



YNF MACHINERY

www.ynfmachinery.com

Guangzhou Xiebang Machinery Co., LTD
Guangzhou Xiebang Machinery Co., Limited



YNF MACHINERY

GUANGZHOU XIEBANG MACHINERY CO., LTD

地址: 广东省广州市天河区珠吉路36号珠吉国际机械市场10街1021/1023档

手机微信同号: 137 6336 7453

固话: 020-3236 4713

ADD: No. 1021 & 1023 Street 10 Zhuji Market, No. 36 Zhuji Road,
Tianhe District, Guangzhou, Guangdong province, China

Mob./WhatsApp: +86 189 2425 0310 / +86-1360 2850 555

Tel: 0086-20-3236 4713

FAX: 0086-20-3236 4713

E-MAIL: sales@ynfmachinery.com / sales@ynfrubber.com

Website: <https://www.ynfmachinery.com>

<https://www.ynfrubber.com>

2023 Version

<https://www.ynfmachinery.com>
<https://www.ynfrubber.com>



About YNF:

YNF is a brand owned by Guangzhou Xiebang Machinery Co., Ltd, which focuses on excavator parts like couplings, mounts, hoses, hydraulic parts, seal kits and gear parts, etc.



Guangzhou Office:

Our Office and showroom are located in Guangzhou, Tian He district. The professional logistic industry in Guangzhou enables us provide fast delivering service to our customers. We attend the Construction Machinery Exhibitions all over the world every year.

Our Factory:

Our excavator parts factory was set up in 1988 in Kaiping city, Guangdong province. And in year 2011 we set up the 2nd factory. Now we are the largest excavator rubber parts supplier in southern China. Factory occupies 4000 square meters and has several full sets of excavator parts production line, around 80 professional workers, 20-million annual production capacity.

Factory manager Mr. Zhang has 24 years excavator parts industrial & manufacture experience. Factory R&D and QC team are rich experienced in excavator parts production line.

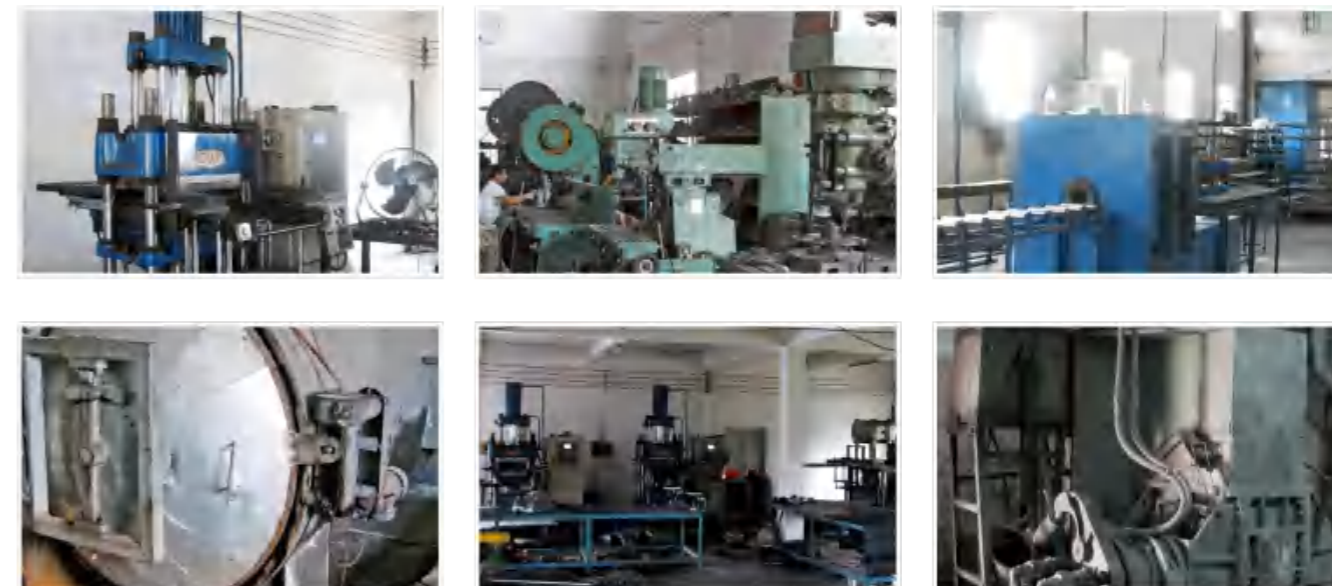

Who We Serve:

Our clients include agents and distributors globally. We also sell excavator parts to final customers in USA, Canada, Australia and Europe.

OEM Welcomed:

Our own factory can make the rubber & iron parts according to customer requirement.

Our Value:

Honest, Positive, Collaborative



COUPLING...01

H SERIES -----	01
K SERIES -----	04
A/AS SERIES -----	09
SPLINE HUB -----	14
FLANGE -----	18
GEAR HUB -----	22
KY SERIES -----	30
GC SERIES -----	31
CB SERIES -----	33
S SERIES -----	34
TFC SERIES -----	34
DAMPER -----	35
YC SERIES -----	35
CLUTCH -----	37
SPIDER COUPLING -----	38
HOSE COUPLING -----	39
RUBBER BLOCK -----	39
J SERIES -----	40

RUBBER MOUNT...41

AIR HOSE...54

RADIATOR WATER HOSE..62

INTER COOLER HOSE...72

OTHER HOSE...73

FAN BLADE...75

HYDRAULIC SEAL...85

FLOATING SEAL / O-RING KIT...90

SEAL KIT...86

PUSHER...91

JOYSTICK VALVE..93

HYDRAULIC PUMP...94

HYDRAULIC PARTS...95

RELIEF VALVE...151

SOLENOID VALVE...157

FLAMEOUT SOLENOID...160

THROTTLE MOTOR...164

POTENTIOMETER / THROTTLE MOTOR CABLE...168

TIMER...170

SENSOR...171

CONTROLLER...179

MONITOR...180

WIRING HARNESS...182

COIL...190

WIPER & WIPER BLADE...191

AIR CONDITIONING SYSTEM PARTS...193

FAN CLUTCH / PLUG...195

CAB INTERIORS...196

DAMPER...204

TENSIONER...204

RUBBER TRACK SHOE...204

DUSTPROOF BOOT...205

LEVER / GRIP / KNOB / PEDAL...207

RUBBER FLOOR MAT...209

CENTER JOINT COVER SEAL...211

OIL TANK COVER / FUEL TANK COVER...213

PULLEY...214

FRONT CASE of MAIN PUMP..216

MANIFOLD TUBE...217

MUFFLER TUBE CAMP / MUFFLER TUBE...218

MUFFLER...220

WATER PUMP...221

OIL PUMP...225

GEAR PARTS / BEARING...226

Coupling - H

Coupling - H



YNF-001
16H (PU)



YNF-002
16H (PU+AL)



YNF02454
16H (AL)



YNF-009
35H (PU)



YNF-010
35H (PU+AL)



YNF02458
35H (AL)



YNF-003
25H (PU) A type



YNF-004
25H (PU+AL) A type



YNF02455
25H (AL) A type



YNF-011
40H (PU)



YNF-012
40H (PU+AL)



YNF02460
40H (AL)



YNF-005
25H (PU) B type



YNF-006
25H (PU+AL) B type



YNF02456
25H (AL) B type



YNF-013
45H (PU)



YNF-014
45H (PU+AL)



YNF02461
45H (AL)



YNF01204
25H (IR) B type



YNF02459
25H (PU+AL+IR) B type



YNF02457
30H (AL)



YNF-015
50H (PU)



YNF-016
50H (PU+AL)



YNF02462
50H (AL)



YNF-007
30H (PU)



YNF-008
30H (PU+AL)



YNF-017
90H (PU)



YNF-018
90H (PU+AL)



YNF02463
90H (AL)

Coupling - H



YNF-019
110H (PU)



YNF-020
110H (PU+AL)



YNF00638
110H (AL)



YNF03349
130H (PU)



YNF03350
130H (PU+AL)



YNF03351
130H (AL)



YNF-021
140H (PU)



YNF-022
140H (PU+AL)



YNF00962
140H (AL)



YNF02346
140H (IR)



YNF02464
140H (PU+AL+IR)



YNF-023
160H (PU)



YNF-024
160H (PU+AL)



YNF2342
160H (AL)

Coupling - H / K



YNF-025
240H (PU)



YNF-026
240H (PU+AL)



YNF02465
240H (AL)



YNF13397
300H (PU)



YNF13398
300H (PU+AL)



YNF13399
300H (AL)



YNF02343
500H (PU)



YNF02344
500H (PU+AL)



YNF02466
500H (AL)



YNF01762
25K (PU)



YNF02345
25K (PU+AL)



YNF02467
25K (AL)



YNF01746
50K (PU)



YNF01747
50K (PU+AL)



YNF02468
50K (AL)

Coupling - K



YNF01748
110K (PU)



YNF01749
110K (PU+AL)



YNF02469
110K (AL)



YNF01750
160K/165K (PU)



YNF01751
160K/165K (PU+AL)



YNF02470
160K/165K (AL)



YNF-027
240K (PU)



YNF-028
240K (PU+AL)



YNF02471
240K (AL)



YNF01752
550K (PU)



YNF01753
550K (PU+AL)



YNF02486
550K (AL)



YNF03813
N165K

Coupling - H

广州携邦机械设备有限公司所提供的联轴器(连接胶)具有优秀的线性抗衰扭的性能.

我们提供的联轴器(连接胶)众多,具有不同的橡胶硬度组合以供选择:



注释: ● ◎ ○ △ ×

有此功能(强) ↔ 无此功能(弱)

The couplings provided by YNF have excellent linear anti-twisting performance.

We offer a wide range of couplings with different rubber hardness combinations to choose from.

Note: ● ◎ ○ △ ×
strong ↔ weak

类型 Series	 A/AS	 H/K
扭矩 (N.m) torque	10~4000	100~2500
规定下的扭矩扭转角 (°)	3~6	0.2~0.3
材质 Material	天然橡胶NR	热塑性聚酯弹性体
工作适宜温度 (°C)	-30~+85	-40~+120
耐油性 Oil resistance	×	●
允许调整范围	平行偏移	○
	角偏移	△
	轴向位移	●
功能和应用	抗震动、抗冲击、灵活性高、耐油性强 应用: 工程机械、发电机、压缩机、通用工业机械	抗震动、抗冲击、耐高温、耐油性强、容易安装和拆卸 应用: 工程机械

Coupling - H



优秀的抗震火热抗冲击性能
弹性酯树脂在运作过程中可以起到橡胶一样的优良抗震吸震性能。

在恶劣环境条件下有更好的抵抗力
这种材料在高温，低温和油脂环境里的抵抗力更强。

优质耐用
聚酯树脂是联轴器（连接胶）耐用的保证，而长期工作寿命也可以缩短扭矩传送建设的时间。枢纽和花键轴都是完全固定在机器上，几乎无磨损转动对维修是要求很低。

容易安装和拆卸
输入和输出可以通过转动轴向来轻松连接和断开。

正常工作扭矩[N.m]	100~2500	
导向孔、额外加工范围[mm]	ø13~115	
工作温度[°C]	-40~+120	
齿隙	Yes	
最大允许调整范围	平行偏移[mm]	0.3~0.4
	角位移动[°]	0.5
	轴向位移[mm]	±3

STRUCTURE AND MATERIAL

结构与材质

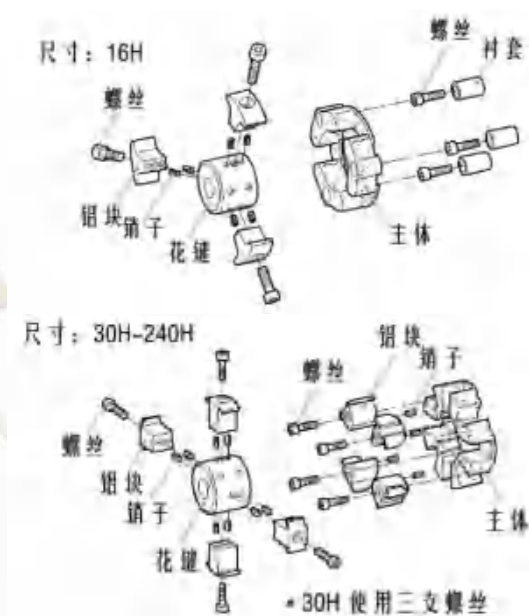

BODY SHAPES OF DIFFERENT SIZES

各个尺寸的主体形状

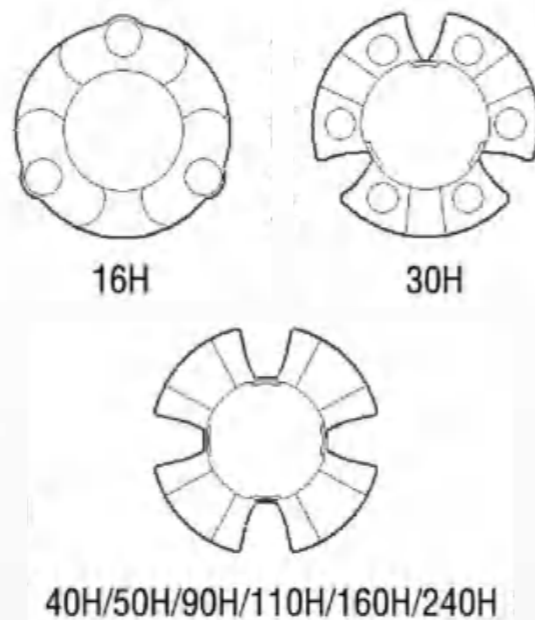

Coupling - H



SPECIFICATIONS

规格

型号	扭矩		最大调整范围			最大转速	动态扭转弹簧常数
	正常扭矩 [N.m]	最大扭矩 [N.m]	平行偏移 [mm]	角位移 [°]	轴向位移 [mm]		
8H	100	200	0.3	0.5	±3	6500	1.27x10 ⁴
16H	200	400	0.3	0.5	±3	5500	2.46x10 ⁴
30H	400	800	0.4	0.5	±3	4000	5.91x10 ⁴
40H	600	1200	0.4	0.5	±3	4000	1.87x10 ⁴
50H	800	1600	0.4	0.5	±3	4000	1.91x10 ⁴
90H	950	1900	0.4	0.5	±3	4000	2.69x10 ⁴
110H	1100	2200	0.4	0.5	±3	4000	2.79x10 ⁴
160H	1600	3200	0.4	0.5	±3	3600	5.11x10 ⁴
240H	2500	5000	0.4	0.5	±3	3000	5.10x10 ⁴

型号	转动惯量 [kg·m ²]	重量 (kg)
8H	9.4x10 ⁻⁴	0.4
16H	3.0x10 ⁻³	0.8
30H	9.2x10 ⁻³	1.5
40H	6.9x10 ⁻³	1.5
50H	1.2x10 ⁻²	1.8
90H	1.5x10 ⁻²	2.5
110H	2.3x10 ⁻²	2.6
160H	3.6x10 ⁻²	3.5
240H	1.02x10 ⁻¹	6.5

SIZE

尺寸

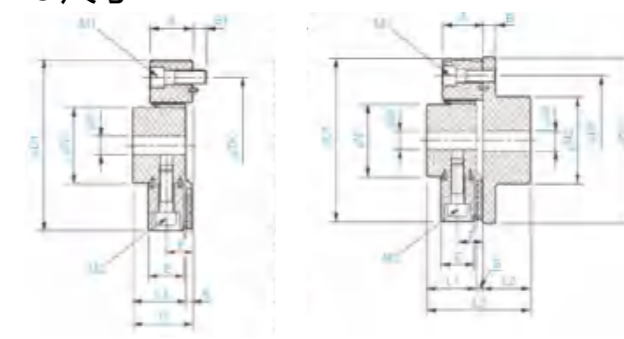

·动态扭转弹簧的特点是非线性，动态扭转弹簧常数应设置在额定转速或是其最高值的20%左右。
·动态扭转弹簧常数是静态扭转弹簧常数的1.3倍。
·惯性和质量的时刻价值是基于先导孔的圆柱和凸缘中心。
作为员工基本的安装方法，建议用镶嵌对齐。

型号	d1	d2	D1	D2	N1	N2	L1	L2	L3	A	B	B1	C	E	F	S	TK	M1=m2		
	导向孔 最大值	导向孔 最大值																		
8H	12	38	15	46	125	120	60	70	40	42	88	32	10	10	46	25	20	6	100	3-M10
16H	15	48	19	56	150	150	70	85	52	50	110	41	12	12	60	34	26	8	125	3-M12
30H	20	65	28	80	200	200	100	120	68	66	144	56	16	15	78	46	35	10	165	3-M16
40H	22	50	22	65	180	180	85	100	58	56	124	50	16	16	68	42	31	10	140	3-M16
50H	20	65	28	80	200	200	100	120	68	66	144	56	16	15	78	46	35	10	165	3-M16
90H	20	65	28	80	200	200	100	120	68	66	144	56	16	15	78	46	35	10	165	3-M16
110H	25	63	28	80	230	230	100	120	68	66	144	56	18	18	78	46	35	10	180	3-M18
160H	30	85	30	95	260	260	125	140	84	80	177	59	19	20	97	48	37	13	215	3-M20
240H	40	115	40	120	320	320	160	180	100	100	213	65	19	20	113	54	40	13	260	3-M20

Coupling - A/AS

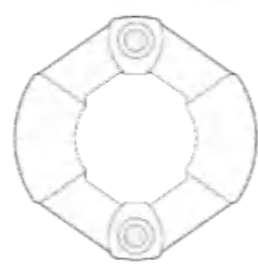
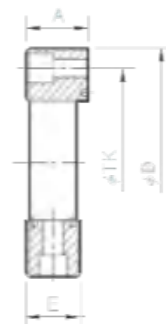

Size 001, 002

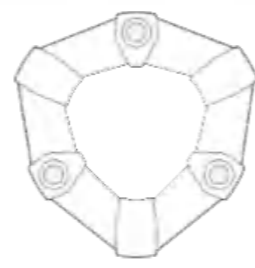

Size 004, 008, 016
025, 030, 090

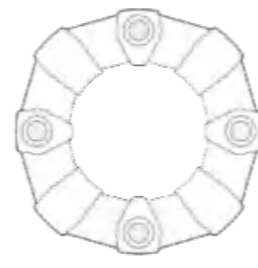

Size 012, 022, 028, 050
080, 140, 200, 250, 400

Size	System Code	D(mm)	TK(mm)	A(mm)	E(mm)
1	Pending	56	44	24	22
2	YNF02338/02339	85	68	24	20
4	YNF-029/030	100	80	28	24
8	YNF-031/032	120	100	32	28
12	YNF-157/158	120	100	32	28
16	YNF-033/034	150	125	42	36
22	YNF-035/036	150	125	42	36
25	YNF-037/038	170	140	46	40
28	YNF-039/040	170	140	46	50
30	YNF-041/042	200	165	58	50
50	YNF-043/044	200	165	58	61
80	YNF-045/046	205	165	65	62
90	YNF-047/048	260	215	70	62
140	YNF-049/050	260	215	70	72
200	YNF-051/052	300	250	80	77
250	YNF-053/054	340	280	85	95
400	YNF-055/056	370	300	105	11
600	Pending	470	380	125	0
800	Pending	545	370+470	145	128

Coupling - A/AS

The difference between A type holes and AS type holes.

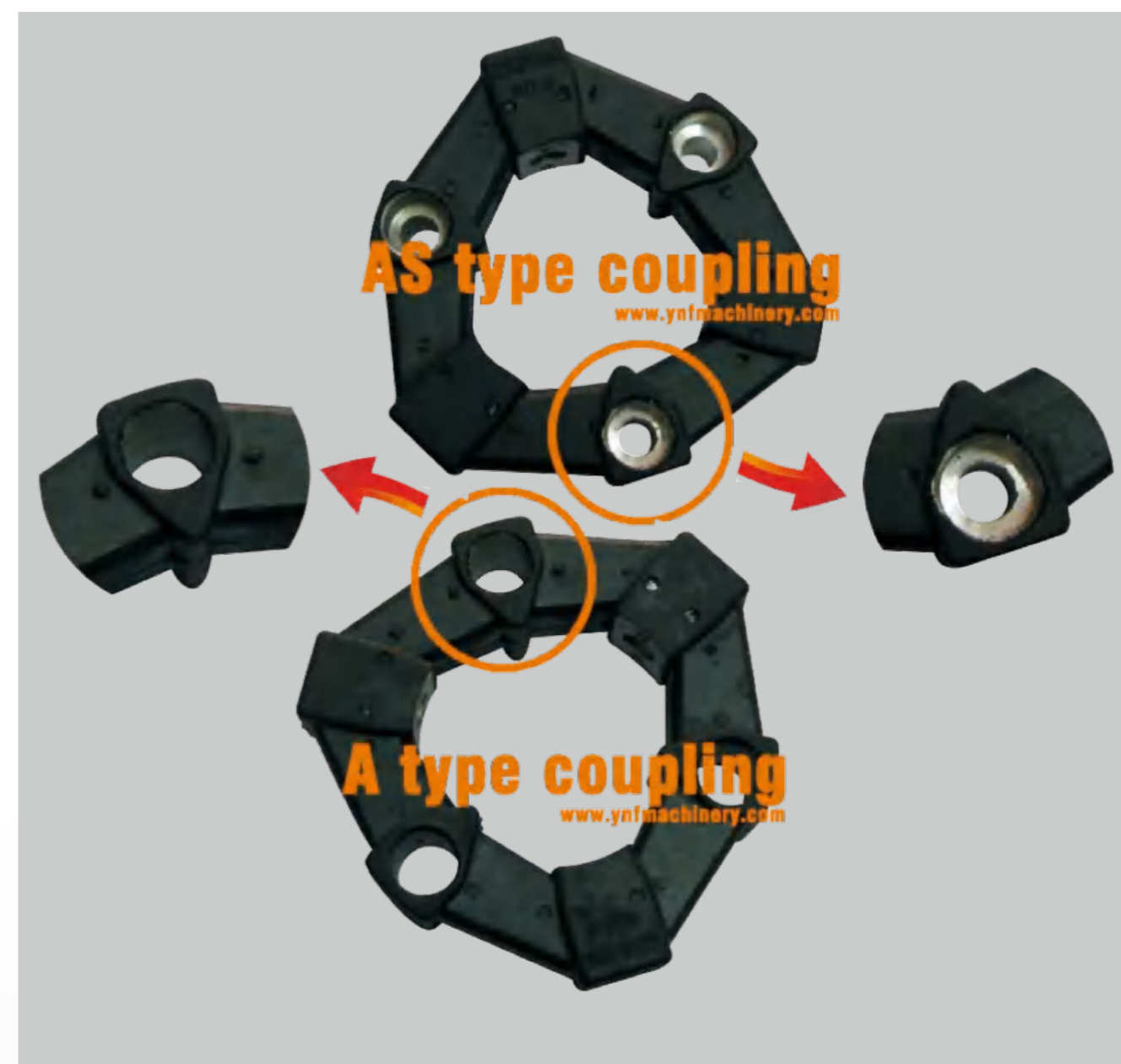

Coupling - A/AS

Coupling - A/AS



YNF02338
2A



YNF02339
2AS



YNF-029
4A



YNF-040
28AS



YNF-041
30A



YNF-042
30AS

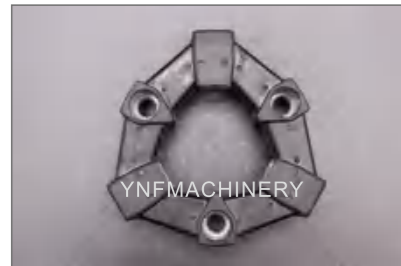

YNF-030
4AS



YNF-031
8A



YNF-032
8AS



YNF-043
50A



YNF-044
50AS



YNF-045
80A



YNF-157
12A



YNF-158
12AS



YNF-033
16A



YNF-046
80AS



YNF-047
90A



YNF-048
90AS



YNF-034
16AS



YNF-035
22A



YNF-036
22AS



YNF02695
90A (Round type)

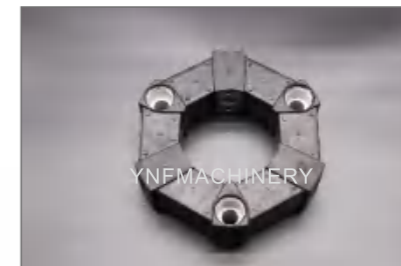

YNF02696
90AS (Round type)



YNF-049
140A



YNF-037
25A



YNF-038
25AS



YNF-039
28A



YNF-050
140AS



YNF03461
140A (Round type)



YNF03462
140AS (Round type)

Coupling - A/AS



YNF-051
200A



YNF-052
200AS



YNF-053
250A



YNF-054
250AS



YNF-055
400A



YNF-056
400AS



YNF-140
MEG1FLEX-B 284

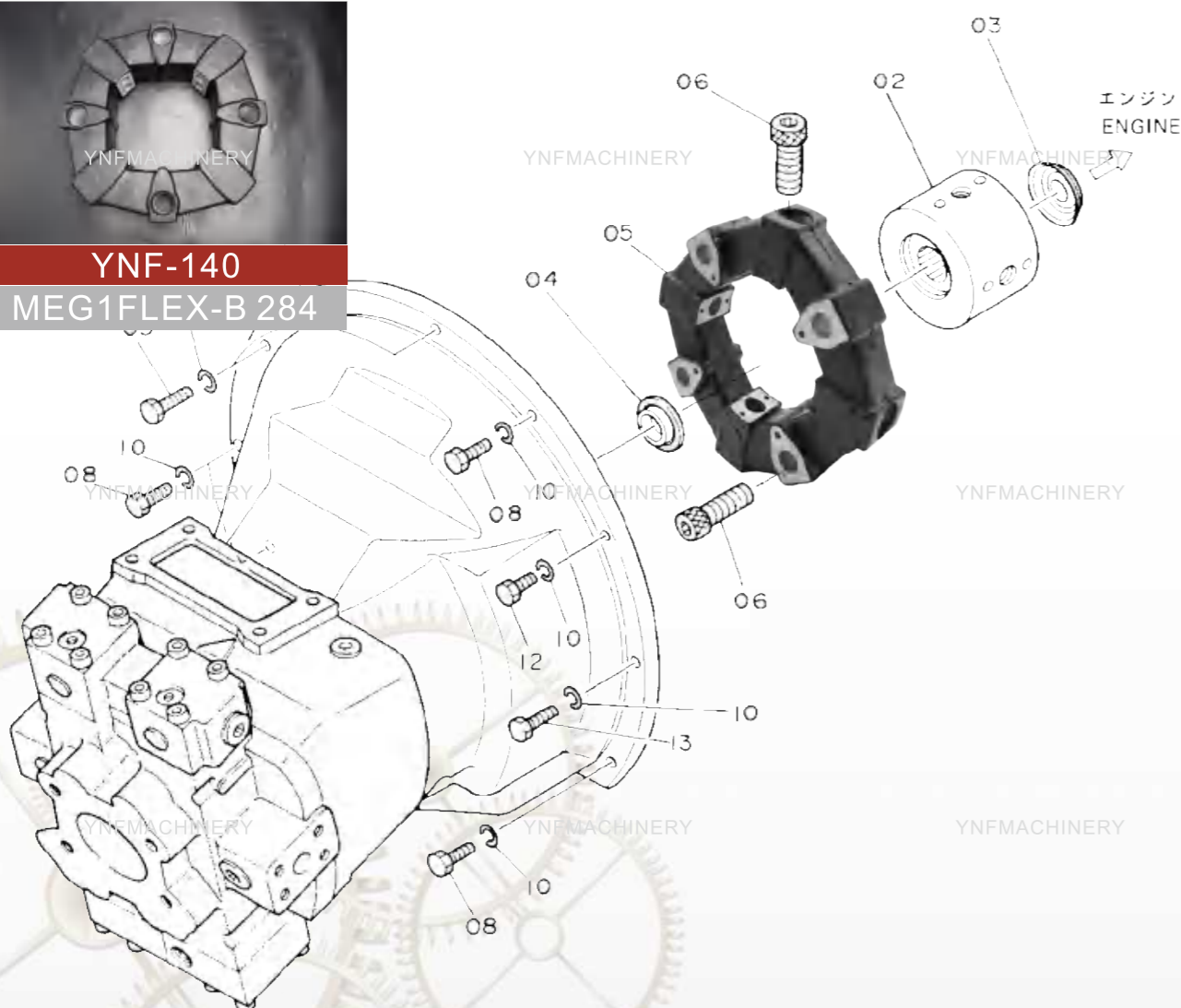

Coupling - Spline Hub

Spline Hub



★ YNFMACHINERY	YNF03710 ★ OD60-9T OD60 ID12/15.6 H36 Z3 10mm	 YNFMACHINERY	YNF01422 ★ OD60-10T OD60 ID14.5/18 H36 Z3 10mm	 YNFMACHINERY	YNF01640 OD60-11T OD60 ID19/16.2 H36 Z3 10mm
 YNFMACHINERY	YNF03413 ★ OD60-13T OD60 ID19/22 H36 Z3 10mm	 YNFMACHINERY	YNF03718 OD60-14T OD60 ID27.3/31.2 H36 Z3 10mm		
★ YNFMACHINERY	YNF03734 ★ OD70-10T OD70 ID14.5/18 H43 Z3 12mm	 YNFMACHINERY	YNF02947 OD70-11T ID16/19 OD70 H46 Z3 12mm	 YNFMACHINERY	YNF02946 OD70-13T OD70 ID19/22 H46 Z3 12mm
 YNFMACHINERY	YNF01880 OD70-13T OD70 ID19/22 H50 Z3 12mm	 YNFMACHINERY	YNF01206 OD70-15T OD70 ID22-26 H37 Z3 12mm		

Coupling - Spline Hub

	YNF02930 OD85-12T OD85 ID30/35 H45 Z4 16mm		YNF01882 OD85-13T OD85 ID19/22 H45 Z3 14mm		YNF00891 OD85-14T OD85 ID27/31 H45 Z3
---	--	---	--	---	---

	YNF01641 OD85-14T OD85 ID35/40 H53		YNF03761 OD85-14T OD85 ID27/31 H43 Z4 16mm		YNF02450 OD85-15T OD85 ID22/26 H45 Z3 14mm
---	---	---	--	---	--

	YNF01474 OD85-15T OD85 ID36/42 H44 Z4 16mm		YNF03567 OD85-16T OD85 ID40/45 H42 Z4 14mm		YNF01213 OD85-16T OD85 ID40/45 H42 16mm
--	--	--	--	--	---

	YNF03545 OD85-17T OD85 ID28/31 H42 Z3 14mm		YNF02121 OD85-17T OD85 ID28/31 H42 Z4		YNF02697 OD85-17T OD85 ID42/47 H45 Z4 16mm
---	--	---	---	---	--

★ 	YNF03694 ★ OD100 H66 Z4 14mm		YNF04083 ★ OD100 ID 55mm		YNF04084 OD100 ID 50mm
---	--	---	---------------------------------------	---	-------------------------------------

★ 	YNF02572 OD100 ID15mm H66 Z4 14mm		YNF00927 OD100-12T OD100 ID30/35 H50 Z4 18mm		YNF01879 OD100-12T OD100 ID30/35 H50 Z4 16mm
---	--	---	--	---	--

Coupling - Spline Hub

	YNF01639 OD100-12T OD100 ID30/35 H65 Z4 16mm		YNF01881 OD100-13T OD100 ID19/22 H55 Z3 16mm		YNF03851 OD100-13T OD100 ID38/46 H62 Z3 16mm
---	--	---	--	---	--

	YNF01198 OD100-14T OD100 ID27/31 H57 Z4 16mm		YNF02139 OD100-14T OD100 ID28/31.5 H66 Z4 16mm		YNF01477 OD100-14T OD100 ID28/33 H66 Z3
---	--	---	--	---	---

	YNF01431 OD100-14T OD100 ID35/40 H50 Z4 16mm		YNF02859 OD100-14T OD100 ID35/40 H50 Z4 18mm		YNF01642 OD100-14T OD100 ID35/40 H62 Z4 18mm
--	--	--	--	--	--

	YNF02325 OD100-15T OD100 ID29/34 H57 Z4 16mm		YNF00805 OD100-15T OD100 ID29/34 H66 Z3 16mm		YNF01096 OD100-15T OD100 ID35/40 H65 Z4 16mm
---	--	---	--	---	--

	YNF01475 OD100-15T OD100 ID36/42 H46 Z4 16mm		YNF00854 OD100-15T OD100 ID44/51 H45 Z4 16mm		YNF02971 OD100-15T OD100 ID44/51 H47 Z4 18mm
---	--	---	--	---	--

	YNF03566 OD100-15T OD100 ID44/51 H50 Z4 18mm		YNF02452 OD100-16T OD100 ID40/45 H62		YNF01210 OD100-17T OD100 ID34/37.8 H54 Z4 16mm
---	--	---	---	---	--

Coupling - Spline Hub

	YNF02841 OD100-17T OD100 ID34/37.8 H54 Z4 16mm		YNF03398 OD100-17T OD100 ID40/46 H64+1 Z4 16mm		YNF03894 OD100-17T OD100 ID40/46 H64+1 Z4 18mm
	YNF03546 OD100-17T OD100 ID42/47 H45 Z4 16mm		YNF03547 OD100-17T OD100 ID42/47 H45 Z4 18mm		YNF03548 OD100-17T OD100 ID42/47.5 H70 Z4 18mm
	YNF01473 OD100-21T OD100 ID40/45 H66 Z3 16mm		YNF03414 OD100-21T OD100 ID40/45 H66 Z4 16mm		
	YNF01643 OD125-14T OD125 ID35/40 H62 Z4 20mm		YNF01476 OD125-15T OD125 ID44/51 H62 Z4 20mm		YNF00846 OD125-17T OD125 ID42/47 H62 Z4 20mm
★ 	YNF02453 OD125-22T OD125 ID56/60 H62 Z4 20mm		YNF02591 OD125-24T OD125 ID46/51 H62 Z4 20mm		
	YNF01479 ★ OD160-15T OD160 ID45/52 H60 Z4 20mm		YNF03549 ★ OD160-17T OD160 ID42/47 H60 Z4 20mm		YNF03821 OD160-21T OD160 ID60/65 H70 Z4 20mm

Coupling - Flange

Flange

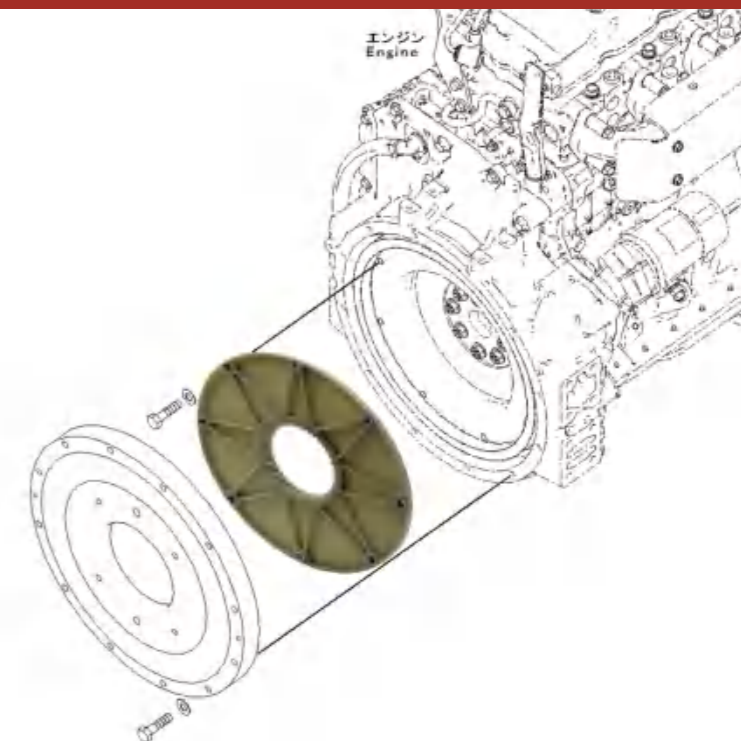













	YNF00946 135x50		YNF-057 150x50		YNF-058 155x50
	YNF02970 165x4		YNF00863 168x26		YNF-059 168x26x13T
	YNF-060 168x47		YNF-061 168x50		YNF-062 178x42

Coupling - Flange

		
YNF-063 180x42	YNF12953 188x50	YNF-064 195x6 (black)
		
YNF02347 200x4	YNF-065 200x50	YNF01763 210x50
		
YNF12734 215x4	YNF12936 215x47	YNF-066 215x50
		
YNF-067 220x46	YNF-068 228x46	YNF02182 230x8
		
YNF02487 240x47	YNF-069 241x4	YNF-069 241x50

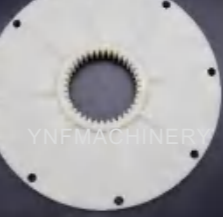
Coupling - Flange

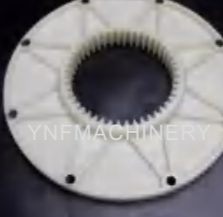
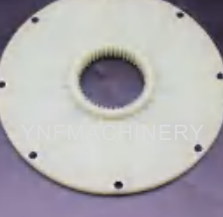
		
YNF12733 260x4	YNF-070 260x46	YNF02488 262x50
		
YNF-071 264x42	YNF-072 295x48	YNF-075 314x4
		
YNF-164 314x6	YNF04059 314x13	YNF04060 314x14
		
YNF04061 314x15	YNF03893 314x38	YNF-073 314x42 (A type)
		
YNF-159 314x42 (B type)	YNF12732 314x46	YNF01600 314x47

Coupling - Flange



YNF-074
314x50 (A type)



YNF02489
314x50 (B type)



YNF04359
352x6 (A type)



YNF04360
352x6 (B type)



YNF-081
352x8 (A type)



YNF02969
352x8 (B type)



YNF04088
OD352



YNF03813
352+165K complete set



YNF-082
352x12



YNF02966
352x38



YNF-076
352x42



YNF-077
352x46



YNF-078
352x48



YNF-079
352x54

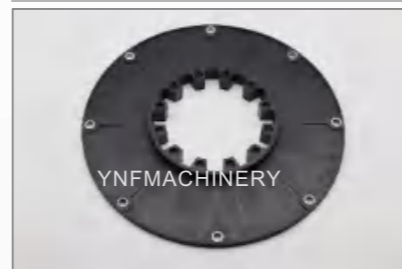

YNF-163
466x12

Coupling - Gear Hub



Outer teeth: 4 teeth



YNF04414

4*13T
OD 94
ID 19.5/23
H 42



YNF03501

4*14T
OD 129/97
ID 27.5/31.5
H 55



YNF04235

4*15T
OD 94
ID 22/26
H 42



YNF13368

4*21T
OD 94
ID 32/35.5
H 41.5



YNF13367

4*23T
OD 94
ID 35/38
H 42

Outer teeth: 6 teeth



YNF03536

6*14T
OD 120/85
ID 28/32
H 50



YNF03537

6*15T
OD 120/85
ID 22/26
H 50



YNF03538

6*15T
OD 120/85
ID 45/51
H 50



YNF03540

6*17T
OD 120/85
ID 27/31
H 50



YNF03541

6*17T
OD 120/85
ID 42/47
H 50

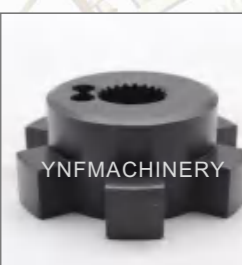

YNF03542

6*21T
OD 120/85
ID 32/35
H 50

Coupling - Gear Hub



Outer teeth: 8 teeth

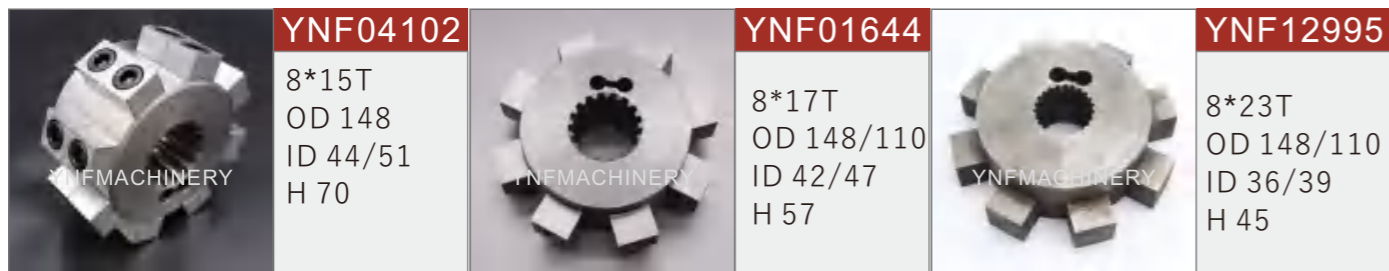

Outer teeth: 12 teeth



Coupling - Gear Hub

Outer teeth: 26 teeth



Outer teeth: 42 teeth

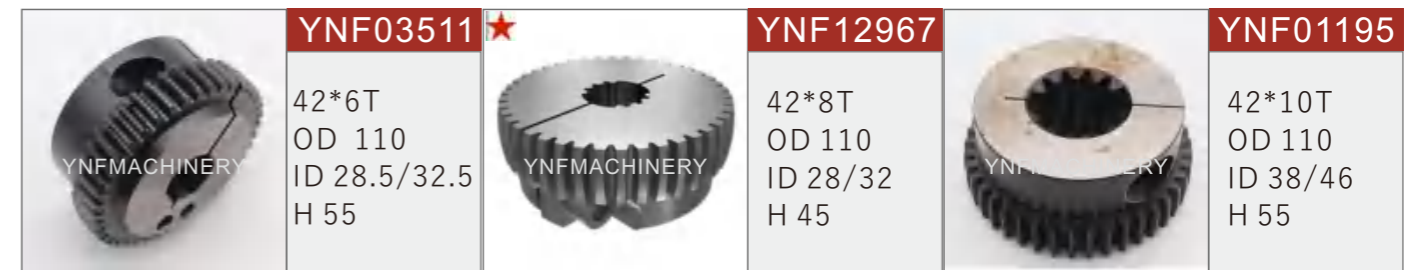

Coupling - Gear Hub

	YNF02478 ★ 42*18T OD 110 ID 36/40 H 70		YNF03715 42*21T OD 110 ID 32/35 H 50		YNF00523 42*21T OD 110 ID 32/35 H 55
---	---	---	---	--	---

	YNF00881 42*21T OD 110 ID 40.5/45.5 H 55		YNF01633 42*23T OD 110 ID 35.2/38.5 H 70		YNF00524 42*23T OD 110 ID 35/38 H 49
---	---	---	---	--	---

	YNF12623 ★ 42*27T OD 110 ID 40/43.5 H 45		YNF00843 42T with key OD 110 ID 25/28 H 55
--	---	--	---

Outer teeth: 46 teeth



	YNF12753 46*10T OD 145 ID 38/46 H 50		YNF01637 46*12T OD 145 ID 30/35 H 56		YNF01471 46*12T OD 145 ID 44/51 H 65
---	---	---	---	--	---

	YNF02643 46*13T OD 145 ID 38/46 H 55		YNF01625 46*13T OD 145 ID 38/46 H 70		YNF00656 46*14T OD 145 ID 27.2/31.2 H 54
---	---	---	---	--	---

Coupling - Gear Hub

	YNF01095 46*14T OD 145 ID 35/40 H 53		YNF03515 46*14T OD 145 ID 35/40 H 55		YNF03516 46*14T OD 145 ID 35/40 H 69
---	---	---	---	---	---

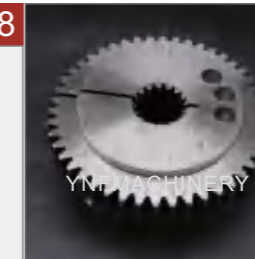
	YNF01289 46*14T OD 145 ID 40/45 H 54		YNF01557 46*14T OD 145 ID 41.6/47.3 H 65		YNF03517 46*15T OD 145 ID 45/52 H 47
---	---	---	---	---	---

	YNF03518 46*15T OD 145 ID 45/52 H 54		YNF02948 46*16T OD 145 ID 30/35 H 54		YNF01472 46*17T OD 145 ID 42/47.5 H 64
--	---	--	---	--	---

	YNF03016 46*17T OD 145 ID 42/47.5 H 81		YNF01627 46*21T OD 145 ID 32/35 H 59		YNF01626 46*21T OD 145 ID 40/45 H 59
---	---	---	---	---	---

	YNF02479 46*23T OD 145 ID 35/38 H 60		YNF01196 46*24T OD 145 ID 46/51 H 57		YNF03519 46*24T OD 145 ID 60/65 H 66
---	---	---	---	---	---

	YNF03520 46*27T OD 145 ID 39/43 H 58		YNF13304 46*27T OD 145 ID 41.5/45 H 57
---	---	---	---

Coupling - Gear Hub



Outer teeth: 47 teeth

	YNF01278 47*13T OD 98 ID 19/22 H 55		YNF03521 47*13T OD 98 ID 38/46.5 H 60		YNF03430 47*14T OD 98 ID 28/32 H 40
---	--	---	--	---	--

	YNF03522 47*14T OD 98 ID 28/32 H 40		YNF02679 47*15T OD 98 ID 22/26 H 46
---	--	---	--



Outer teeth: 48 teeth

	YNF01398 48*13T OD 176 ID 38/46 H 65		YNF01634 48*13T OD 176 ID 38/46 H 74		YNF03554 48*13T OD 176 ID 38/46 H 74
---	---	---	---	---	---

	YNF01421 48*14T OD 176 ID 35/40 H 66		YNF02600 48*15T OD 176 ID 45/52 H 58		YNF03524 48*17T OD 176 ID 42/47 H 58
---	---	---	---	---	---

	YNF01205 48*17T OD 176 ID 42/47 H 63		YNF03523 48*21T OD 176 ID 40.5/45.5 H 57		YNF01566 48*24T OD 176 ID 45.5/50.5 H 64
---	---	---	---	---	---

Coupling - KY



	YNF03525 48*24T OD 176 ID 45.5/50.5 H 110		YNF03526 48*27T OD 176 ID 45/48 H 65		YNF04296 48*27T OD 176 ID 41/45 H 70
---	--	---	---	---	---

	YNF13700 48*27T OD 176 ID 44.9/48.2 H 58.8		YNF02571 48*28T OD 176 ID 56.5/61 H 70
---	---	---	---

Outer teeth: 50 teeth



	YNF03527 50*6T OD 78 ID 19.7/23.9 H 42.9		YNF02682 50*10T OD 78 ID 19/22.8 H 36.5		YNF12439 50*10T OD 78 ID 28/32 H 44
--	---	--	--	--	--

	YNF01084 50*11T OD 78 ID 16/19 H 42		YNF00864 50*13T OD 78 ID 19/22 H 44		YNF03472 50*13T OD 78 ID 20/22.5 H 43
---	--	---	--	---	--



	YNF00947 50*14T OD 78 ID 28/32 H 44		YNF01638 50*15T OD 78 ID 22/26 H 44		YNF02840 50*15T OD 78 ID 29/33.2 H 44
---	--	---	--	---	--

	YNF02837 50*12T OD 130 ID 30/35 H 54		YNF03415 50*13T OD 130 ID 38/46 H 55		YNF00618 50*14T OD 130 ID 28/32 H 55
---	---	---	---	---	---

Coupling - Gear Hub



	YNF00619 50*14T OD 130 ID 28/32 H 68		YNF02833 50*14T OD 130 ID 35/40 H 54		YNF03141 50*14T OD 130 ID 35/40 H 68
---	---	---	---	--	---

	YNF03528 50*15T OD 130 ID 29/34 H 54		YNF03827 50*15T OD 130 ID 44/51 H 55		YNF03529 50*17T OD 130 ID 42/47 H 67
---	---	---	---	--	---

	YNF03530 50*21T OD 130 ID 40.2/45.3 H 70		YNF03530 50*21T OD 130 ID 40.5/45.5 H 54		YNF03531 50*23T OD 130 ID 35/38 H 54
--	---	--	---	---	---

	YNF03532 50*24T OD 130 ID 46/51 H 53
---	---

Outer teeth: 54 teeth

	YNF01427 54*15T OD 225 ID 44/51 H 71.5		YNF03552 ★ 54*17T OD 225 ID 42/47.5 H 72.8		YNF02490 54*18T OD 225 ID 36/40 H 71
---	---	---	---	--	---

Coupling - KY



YNF03872
180x50T



YNF01057
241x42T



YNF-161
314x46T



YNF-105
314KY (With Hub)



YNF-106
352x46T



YNF03952
198x50T



YNF01778
241x50T (Iron Bottom)



YNF-160
314x46T (Iron Bottom)



YNF05150
352KY (with hub)



YNF04437
466KY



YNF-104
215x50T



YNF12695
314x42T (Iron Bottom)

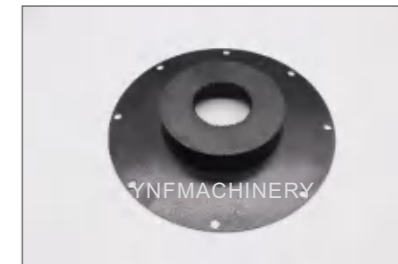

YNF00888
314x50T (Iron Bottom)



YNF-162
352x46T (Iron Bottom)



YNF01779
466x48T (Iron Bottom)

Coupling - GC

Coupling - GC

GC Series



YNF03797
466x54T



YNF04354
LKB1000



YNF-095
245x12T



YNF-096
262x24T



YNF-097
270x24T



YNF02474
338x24T (16z)



YNF01754
340x24T (24z)



YNF01776
388x24T



YNF03379
275x24T



YNF-098
295x24T



YNF03820
301x24T



YNF03387
402x24T (Without Hub)



YNF03387-1
402x24T (With Hub)



YNF02593
406x24T



YNF03886
300x24T



YNF02473
305x24T



YNF-099
301x24T ID56



YNF02965
428x24T



YNF03850
430x24T (12z)



YNF03745
435x24T (8z)



YNF12639
301x24T ID59.5



YNF01755
338x24T (8z)



YNF-100
335x24Tx12T



YNF01777
435x24T (8z+8z)



YNF12244
435x28T HCT400A



YNF-102
440x24T

Coupling - CB/S

		
YNF03880 442x24T	YNF-103 450x24T	YNF-103H 450x24T (thick type)
		
YNF13067 648x24T	YNF13068 645x24T	YNF04043 CB116-11T
		
YNF-115 CB116-13T	YNF-116 CB116-14T	YNF-117 CB146-13T
		
YNF03844 CB146-14T	YNF-118 CB146-15T	YNF-119 CB146-17T
		
YNF-120 CB160-13T	YNF-121 CB160-15T	YNF02596 CB160-14T

Coupling - TFC/Rubber Block

		
YNF03203 S22S OD132	YNF-092 S25S OD143	YNF-093 S29S OD150
		
YNF-094 S32S OD239	YNF01619 SAGA034	YNF01757 GA028
		
YNF-086 15T SH160	YNF-083 12T	YNF-084 14T SH200 50ACM
		
YNF-085 14T E200B 50AC	YNF-087 15T E320B	YNF-088 16T 50AM
		
YNF-089 16T E300B	YNF-090 16T E450	YNF-091 20T SH280 50ASM

Coupling - Damper/YC



YNF-122
PC60-7 PC75UU 4D102
[210×22×19]



YNF-123
PC60-7 4D95
[180×22×19]



YNF-124
PC100 PC60-5 PC50-6
[180×18×16]



YNF-125
PC120-5 PC60-5
PC60-6 change pump
[180×18×14]



YNF-126
PC120-6 4D102
[220×17×16]



YNF-127
PC120-6 4D95
[168×17×16]



YNF-128
PC130-7
[168×18×18]



YNF03858
YC18 (without hub)



YNF-107
YC18 9T



YNF01764
YC18 13T



YNF12766
YC18 14T



YNF02574
YC18 15T



YNF03853
YC35 (without hub)

Coupling - YC



YNF-108
YC35-9T



YNF-109
YC35-13T



YNF-110
YC35-14T



YNF01765
YC60-7 175-9T



YNF01766
YC60-7 175-13T



YNF01767
YC60-7 175-14T



YNF-112
YC60-7 175-15T



YNF01768
YC60-8 240-9T



YNF01769
YC60-8 240-13T



YNF01770
YC60-8 240-14T



YNF-113
YC60-8 240-15T



YNF-114
FR60 180-15T



YNF03837
E304 E305.5 13T



YNF12595
E304 14T



YNF03836
E304 15T

Coupling - Cluth



YNF02828
D65-15 22T



YNF0129
D6-12 D65 22T



YNF0133
PC200-3 16T



YNF0134
PC200-5 PC200-6 16T



YNF0135
PC200-7 PC200-8 16T



YNF0136
PC300-6/400-6/400-7 22T



YNF0137
PC300-7 20T



YNF01758
14T K3V63 OD344×14T



YNF01759
PC180-6 24T



YNF01760
E345 15T



YNF05215
E345 17T

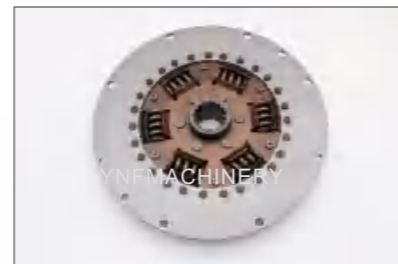

YNF0130
R445 R450



YNF0138
Liebherr R934 R944 24T



YNF05216
DH400-7

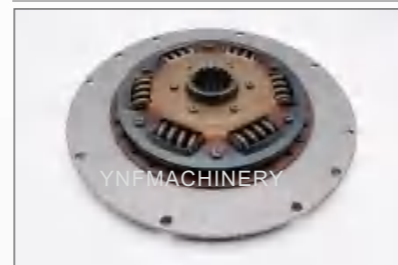

YNF05217
EC360 EC460 17T

Coupling - GR Spider Coupling



YNF01761
without gear hub



YNF11251
D31 D37



YNF11247
D41 D53

Spider Coupling



YNF03484
GR28



YNF03485
GR42



YNF03486
GR48



YNF03487
GR55



YNF03488
GR65



YNF03489
GR75



YNF03490
GR90



YNF03491
GR100



YNF03492
GR110

Coupling - Hose Coupling

Coupling - J series

Hose Coupling Seal & Assembly



Hose Coupling Seal

Purchase No.	Size
YNF0139	φ25
YNF0140	φ32
YNF02544	φ34
YNF0141	φ38
YNF0142	φ42
YNF12500	φ45
YNF0143	φ48
YNF0144	φ51
YNF0145	φ56
YNF0146	φ60
YNF0147	φ76
YNF0148	φ90

Hose Coupling Assembly

Purchase No.	Size
YNF0149	φ25
YNF0150	φ32
YNF02545	φ34
YNF0151	φ38
YNF0152	φ42
YNF12501	φ45
YNF0153	φ48
YNF0154	φ51
YNF0155	φ56
YNF0156	φ60
YNF0184	φ76

Rubber Block



YNF02815
OD75XH55



YNF03469
OD90XH70



YNF03470
OD75XH70



J SERIES COUPLINGS



YNF12742
3J



YNF12743
4J



YNF12744
5J



YNF12745
6J



YNF12746
7J



YNF12747
8J



YNF12748
9J



YNF03859
10J



YNF12749
11J



YNF12750
12J



YNF12751
13J



YNF12908
14J